



Professional Wide Terminal Thin Film Chip Resistors



MCW 0406 AT Professional Wide Terminal Resistors are the perfect choice for most fields of modern professional power measurement electronics where reliability, stability, power dissipation, and robust design is of major concern.

Beside extremely high power ratings, the MCW 0406 AT is characterized by extraordinary temperature cycling robustness, verified through extensive testing. The permissible power rating is specified with 300 mW. Typical applications include power electronics in automotive and industrial appliances.

FEATURES

- Rated dissipation P_{85} up to 300 mW
- Superior temperature cycling robustness
- Operating temperature up to 175 °C for 1000 h
- AEC-Q200 qualified
- Material categorization: For definitions of compliance please see www.vishay.com/doc?99912



RoHS COMPLIANT

APPLICATIONS

- Automotive
- Industrial
- High power and high temperature applications
- Replacement for larger case sizes

TECHNICAL SPECIFICATIONS	
DESCRIPTION	MCW 0406 AT
Imperial size	0406
Metric size code	RR1016M
Resistance range ⁽¹⁾	1 Ω to 100 kΩ
Resistance tolerance	± 0.5 %; ± 1 %
Temperature coefficient	± 25 ppm/K; ± 50 ppm/K
Rated dissipation P_{85} ⁽²⁾	0.3 W
Operating voltage, U_{max} . AC _{RMS} or DC	50 V
Permissible film temperature, $\theta_{F max}$. ⁽²⁾	175 °C
Operating temperature range ⁽²⁾	- 55 °C to 175 °C
Insulation voltage	
1 min; U_{ins}	75 V
Continuous	75 V
Failure rate: FIT _{observed}	To be established

Notes

- ⁽¹⁾ The AEC-Q200 qualification of the extended range < 47 Ω is pending.
⁽²⁾ Please refer to APPLICATION INFORMATION, see next page.

APPLICATION INFORMATION

The power dissipation on the resistor generates a temperature rise against the local ambient, depending on the heat flow support of the printed-circuit board (thermal resistance). The rated dissipation applies only if the permitted film temperature is not exceeded. Furthermore, a high level of ambient temperature or of power dissipation may raise the temperature of the solder joint, hence special solder alloys or board materials may be required to maintain the reliability of the assembly.

These resistors do not feature a lifetime limitation when operated within the limits of rated dissipation, permissible operating voltage and permissible film temperature. However, the resistance typically increases due to the resistor's film temperature over operating time, generally known as drift. The drift may exceed the stability requirements of an individual application circuit and thereby limits the functional lifetime. At the maximum permissible film temperature of 175 °C the useful lifetime is specified for 1000 h. The designer may estimate the performance of the particular resistor application or set certain load and temperature limits in order to maintain a desired stability.

MAXIMUM RESISTANCE CHANGE AT RATED DISSIPATION			
OPERATION MODE	STANDARD	POWER	ADVANCED TEMPERATURE
Rated dissipation MCW 0406 AT	P_{70} 0.200 W	P_{70} 0.250 W	P_{85} 0.300 W
Applied maximum film temperature, $\vartheta_{F \max.}$	125 °C	155 °C	175 °C
Max. resistance change at rated dissipation for resistance range: MCW 0406 AT	1 Ω to 100 kΩ	1 Ω to 100 kΩ	1 Ω to 100 kΩ
$ \Delta R/R _{\max.}$, after:			
1000 h	≤ 0.15 %	≤ 0.3 %	≤ 0.5 %
8000 h	≤ 0.25 %	≤ 0.5 %	-
225 000 h	≤ 1.0 %	-	-

The resistance value is influenced by the resistance of the terminations. The exact resistance value of the soldered part on the PCB may deviate depending on e.g. solder quantity, pad layout, and soldering method. The resistance value of the unmounted part can be verified for resistors < 10 Ω by a 4-point probe on the top side termination as shown below.

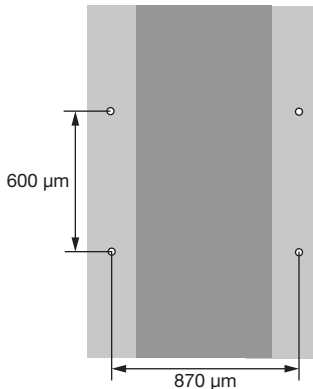

Fig. 1



PART NUMBER AND PRODUCT DESCRIPTION																	
Part Number: MCW0406MD4641DPW00																	
M	C	W	0	4	0	6	M	D	4	6	4	1	D	P	W	0	0
TYPE/SIZE		VERSION			TCR		RESISTANCE			TOLERANCE		PACKAGING					
MCW0406		M = AT (Automotive)			D = ± 25 ppm/K C = ± 50 ppm/K		3 digit value 1 digit multiplier			D = ± 0.5 % F = ± 1 %		P5 PW					
MULTIPLIER 8 = *10 ⁻² 9 = *10 ⁻¹ 0 = *10 ⁰ 1 = *10 ¹ 2 = *10 ² 3 = *10 ³																	
Product Description: MCW 0406-25 0.5 % AT PW 4K64																	
MCW	0406	-25	0.5 %	AT	PW	4K64											
TYPE	SIZE	TCR	TOLERANCE	VERSION	PACKAGING	RESISTANCE											
MCW	0406	± 25 ppm/K ± 50 ppm/K	± 0.5 % ± 1 %	AT = Automotive	P5 PW	4K64 = 4.64 kΩ											

Note

- Products can be ordered using either the PART NUMBER or PRODUCT DESCRIPTION.

TEMPERATURE COEFFICIENT AND RESISTANCE RANGE		
DESCRIPTION		RESISTANCE
TCR	TOLERANCE	MCW 0406 AT
± 50 ppm/K	± 1 %	1 Ω to 100 kΩ
± 25 ppm/K	± 0.5 %	

Note

- Resistance values are available for ± 1 % tolerance from the E24 and E96 series; for ± 0.5 % tolerance from the E24 and E192 series.

PACKAGING						
TYPE	CODE	QUANTITY	CARRIER TAPE	WIDTH	PITCH	REEL DIAMETER
MCW 0406 AT	P5	5000	Tape and reel cardboard tape acc. IEC 60286-3 type I	8 mm	4 mm	180 mm/7"
	PW	20 000				330 mm/13"



DESCRIPTION

Production is strictly controlled and follows an extensive set of instructions established for reproducibility. A homogeneous film of special metal alloy is deposited on a high grade ceramic substrate (Al_2O_3) and conditioned to achieve the desired temperature coefficient. Specially designed inner contacts are deposited on both sides. A special laser is used to achieve the target value by smoothly cutting a meander groove in the resistive layer without damaging the ceramics. The resistor elements are covered by a unique protective coating designed for electrical, mechanical and climatic protection. The terminations receive a final pure tin on nickel plating.

The result of the determined production is verified by an extensive testing procedure and optical inspection performed on 100 % of the individual chip resistors. This includes full screening for the elimination of products with potential risk of early field failures (feasible for $R \geq 10 \Omega$). Only accepted products are laid directly into the paper tape in accordance with **IEC 60286-3** ⁽¹⁾.

ASSEMBLY

The resistors are suitable for processing on automatic SMD assembly systems. They are suitable for automatic soldering using reflow or vapour phase as shown in **IEC 61760-1** ⁽¹⁾. The encapsulation is resistant to all cleaning solvents commonly used in the electronics industry, including alcohols, esters and aqueous solutions. The suitability of conformal coatings, if applied, shall be qualified by appropriate means to ensure the long-term stability of the whole system.

The resistors are RoHS compliant; the pure tin plating provides compatibility with lead (Pb)-free and lead-containing soldering processes. Solderability is specified for 2 years after production or requalification. The permitted storage time is 20 years. The immunity of the plating against tin whisker growth has been proven under extensive testing.

Note

⁽¹⁾ The quoted IEC standards are also released as EN standards with the same number and identical contents.

All products comply with the **JIG 101** list of legal restrictions on hazardous substances.

This includes full compliance with the following directives:

- 2000/53/EC End of Life Vehicle Directive (ELV) and Annex II (ELV II)
- 2011/65/EU Restriction of the use of Hazardous Substances Directive (RoHS)
- 2002/96/EC Waste Electrical and Electronic Equipment Directive (WEEE)

APPROVALS

Where applicable the resistors are tested within the IECQ-CECC Quality Assessment System for Electronic Components to the detail specification **EN 140401-801** which refers to **EN 60115-1**, **EN 140400** and the variety of environmental test procedures of the **IEC 60068** ⁽¹⁾ series. The detail specification refers to the climatic categories 55/125/56, which relates to the "standard operation mode" of this datasheet. The MCW 0406 AT is AEC-Q200 qualified. The AEC-Q200 qualification of the extended range $< 47 \Omega$ is pending.

Vishay BEYSCHLAG has achieved "Approval of Manufacturer" in accordance with **IECQ 03-1**. The release certificate for "Technology Approval Schedule" in accordance with **CECC 240001** based on **IECQ 03-3** is granted for the Vishay BEYSCHLAG manufacturing process.

RELATED PRODUCTS

For an alternative range of TCR and tolerance see the datasheet:

- Precision Wide Terminal Thin Film Chip Resistors (www.vishay.com/doc?28847)

FUNCTIONAL PERFORMANCE

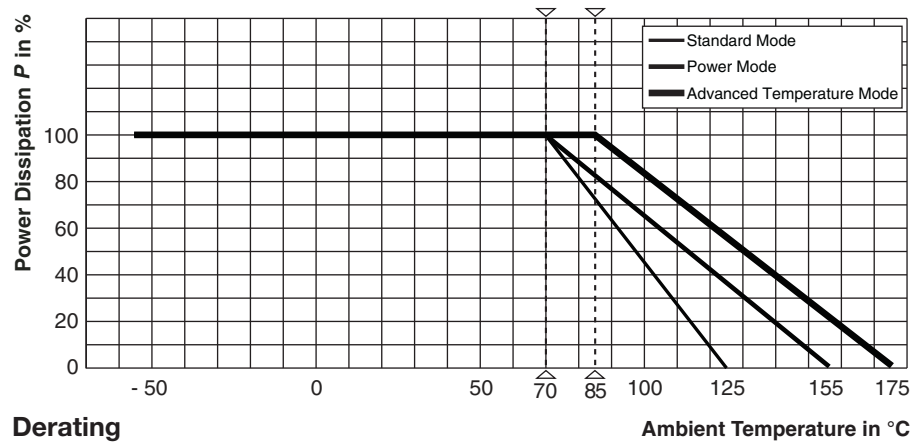

Note

- For the permissible resistance change in each operation mode please refer to table MAXIMUM RESISTANCE CHANGE AT RATED DISSIPATION, above.

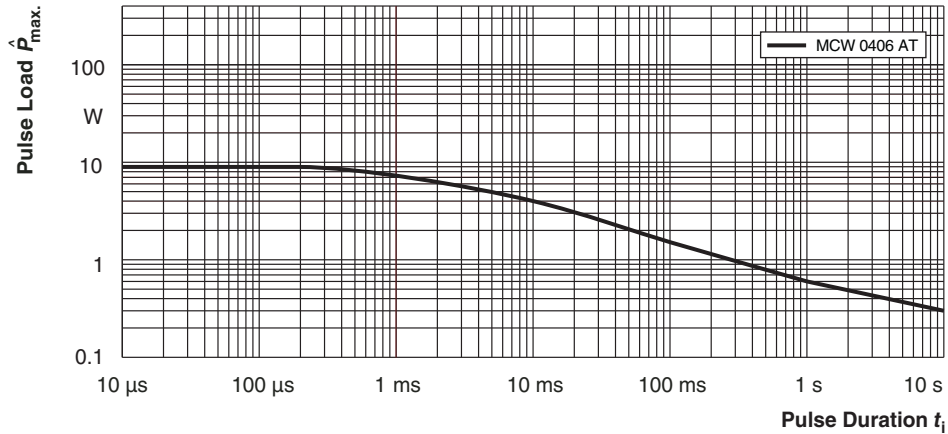

Maximum pulse load, single pulse; applicable if $\bar{P} \rightarrow 0$ and $n \leq 1000$ and $\hat{U} \leq \hat{U}_{max}$; for permissible resistance change equivalent to 8000 h operation in standard operation mode

Single Pulse

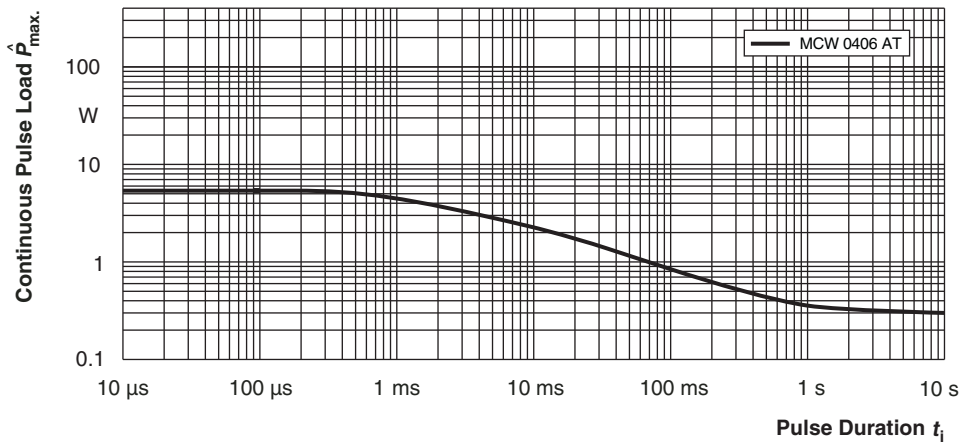

Maximum pulse load, continuous pulses; applicable if $\bar{P} \leq P(\vartheta_{amb})$ and $\hat{U} \leq \hat{U}_{max}$;
for permissible resistance change equivalent to 8000 h operation in standard operation mode

Continuous Pulse

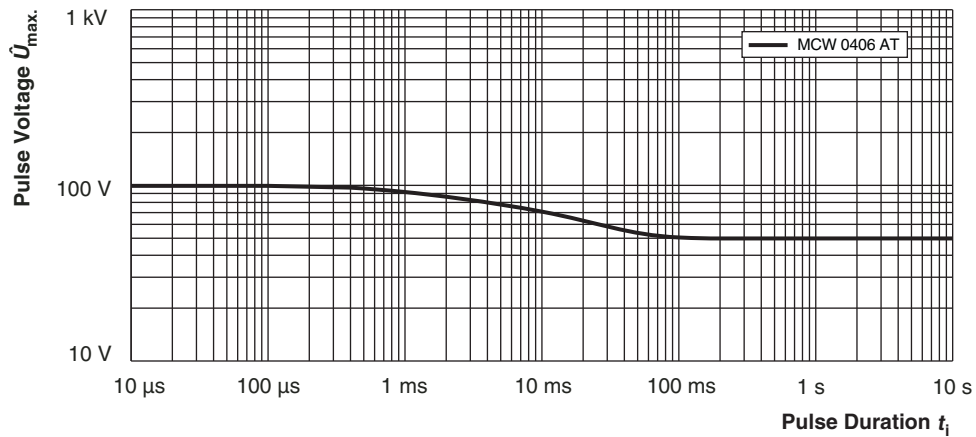

Maximum pulse voltage, single and continuous pulses; applicable if $\hat{P} \leq \hat{P}_{max}$;
for permissible resistance change equivalent to 8000 h operation in standard operation mode

Pulse Voltage

TESTS AND REQUIREMENTS

All tests are carried out in accordance with the following specifications:

- EN 60115-1, generic specification
- EN 140400, sectional specification
- EN 140401-801, detail specification

The testing also covers most of the requirements specified by EIA/ECA-703 and JIS-C-5201-1.

The tests are carried out under standard atmospheric conditions in accordance with IEC 60068-1, 5.3. A climate category is applied, defined by the lower category temperature (LCT), the upper category temperature (UCT), and the number of days of the damp heat, steady-state test (56).

Unless otherwise specified the following values apply:

Temperature: 15 °C to 35 °C

Relative humidity: 45 % to 75 %

Air pressure: 86 kPa to 106 kPa (860 mbar to 1060 mbar).

The components are mounted for testing on boards in accordance with EN 140400, 2.3.3 unless otherwise specified.

The requirements stated in the Test Procedures and Requirements table are based on the required tests and permitted limits of EN 140401-801. However, some additional tests and a number of improvements against those minimum requirements have been included.



TEST PROCEDURES AND REQUIREMENTS				
EN 60115-1 CLAUSE	IEC 60068-2 TEST METHOD	TEST	PROCEDURE	REQUIREMENTS PERMISSIBLE CHANGE (ΔR)
			Stability for product types:	
			MCW 0406 AT	1 Ω to 100 k Ω
4.5	-	Resistance		$\pm 1 \% R$; $\pm 0.5 \% R$
4.8.4.2	-	Temperature coefficient	At (20/- 55/20) °C and (20/155/20) °C	± 50 ppm/K; ± 25 ppm/K
4.25.1	-	Endurance at 70 °C: Standard operation mode	$U = \sqrt{P_{70} \times R}$ or $U = U_{max.}$; whichever is the less severe; 1.5 h on; 0.5 h off; 70 °C; 1000 h 70 °C; 8000 h	$\pm (0.15 \% R + 0.05 \Omega)$ $\pm (0.25 \% R + 0.05 \Omega)$
		Endurance at 70 °C: Power operation mode	$U = \sqrt{P_{70} \times R}$ or $U = U_{max.}$; whichever is the less severe; 1.5 h on; 0.5 h off; 70 °C; 1000 h 70 °C; 8000 h	$\pm (0.3 \% R + 0.05 \Omega)$ $\pm (0.5 \% R + 0.05 \Omega)$
		Endurance at 85 °C: Advanced temperature operation mode	$U = \sqrt{P_{85} \times R}$ or $U = U_{max.}$; 1.5 h on; 0.5 h off; 85 °C; 1000 h	$\pm (0.5 \% R + 0.05 \Omega)$
4.25.3	-	Endurance at upper category temperature	125 °C; 1000 h 155 °C; 1000 h 175 °C; 1000 h	$\pm (0.15 \% R + 0.02 \Omega)$ $\pm (0.3 \% R + 0.05 \Omega)$ $\pm (0.5 \% R + 0.05 \Omega)$
4.24	78 (Cab)	Damp heat, steady state	(40 \pm 2) °C; 56 days; (93 \pm 3) % RH	$\pm (0.1 \% R + 0.05 \Omega)$
4.39	67 (Cy)	Damp heat, steady state, accelerated: Standard operation mode	(85 \pm 2) °C (85 \pm 5) % RH $U = \sqrt{0.1 \times P_{70} \times R}$; $U \leq 0.3 \times U_{max.}$; 1000 h	$\pm (0.5 \% R + 0.05 \Omega)$
4.23	2 (Bb) 30 (Db) 1 (Ab) 13 (M) 30 (Db) -	Climatic sequence: Standard operation mode:		$\pm (0.5 \% R + 0.05 \Omega)$
4.23.2		Dry heat	155 °C; 16 h	
4.23.3		Damp heat, cyclic	55 °C; 24 h; ≥ 90 % RH; 1 cycle	
4.23.4		Cold	- 55 °C; 2 h	
4.23.5		Low air pressure	8.5 kPa; 2 h; (25 \pm 10) °C	
4.23.6		Damp heat, cyclic	55 °C; 24 h; ≥ 90 % RH; 5 cycles	
4.23.7		DC load	$U = \sqrt{P_{70} \times R} \leq U_{max.}$; 1 min	
-	1 (Ab)	Storage at low temperature	- 55 °C; 2 h	$\pm (0.1 \% R + 0.01 \Omega)$
4.19	14 (Na)	Rapid change of temperature	30 min at - 55 °C and 30 min at 155 °C; 1000 cycles	$\pm (0.25 \% R + 0.05 \Omega)$
4.13	-	Short time overload: Standard operation mode	$U = 2.5 \times \sqrt{P_{70} \times R}$ or $U = 2 \times U_{max.}$; whichever is the less severe;	$\pm (0.1 \% R + 0.01 \Omega)$
		Short time overload: Power operation mode	5 s	$\pm (0.25 \% R + 0.05 \Omega)$

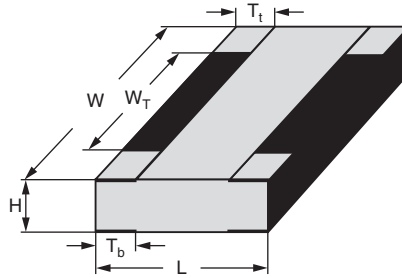

TEST PROCEDURES AND REQUIREMENTS				
EN 60115-1 CLAUSE	IEC 60068-2 TEST METHOD	TEST	PROCEDURE	REQUIREMENTS PERMISSIBLE CHANGE (ΔR)
			Stability for product types:	
			MCW 0406 AT	1 Ω to 100 k Ω
4.27	-	Single pulse high voltage overload: Standard operation mode	Severity no. 4: $U = 10 \times \sqrt{P_{70} \times R}$ or $U = 2 \times U_{max.}$; whichever is the less severe; 10 pulses 10 μ s/700 μ s	To be determined
		Single pulse high voltage overload: Power operation mode		To be determined
4.37	-	Periodic electric overload: Standard operation mode	$U = \sqrt{15 \times P_{70} \times R}$ or $U = 2 \times U_{max.}$ whichever is the less severe; 0.1 s on; 2.5 s off; 1000 cycles	To be determined
		Periodic electric overload: Power operation mode		To be determined
4.40	-	Electro Static Discharge (Human Body Model)	IEC 61340-3-1; 3 pos. + 3 neg. (equivalent to MIL-STD-883, method 3015) 500 V	$\pm (0.5 \% R + 0.05 \Omega)$
4.22	6 (Fc)	Vibration	Endurance by sweeping; 10 Hz to 2000 Hz; no resonance; amplitude ≤ 1.5 mm or ≤ 200 m/s ² ; 7.5 h	$\pm (0.1 \% R + 0.01 \Omega)$ no visible damage
4.17.2	58 (Td)	Solderability	Solder bath method; SnPb40; non-activated flux (215 \pm 3) $^{\circ}$ C; (3 \pm 0.3) s	Good tinning (≥ 95 % covered); no visible damage
			Solder bath method; SnAg3Cu0.5 or SnAg3.5; non-activated flux; (235 \pm 3) $^{\circ}$ C; (2 \pm 0.2) s	Good tinning (≥ 95 % covered); no visible damage
4.18.2	58 (Td)	Resistance to soldering heat	Solder bath method; (260 \pm 5) $^{\circ}$ C; (10 \pm 1) s	$\pm (0.1 \% R + 0.02 \Omega)$ no visible damage
4.29	45 (XA)	Component solvent resistance	Isopropyl alcohol + 50 $^{\circ}$ C; method 2	No visible damage
4.32	21 (Ue ₃)	Shear (adhesion)	RR1016M; 9 N	No visible damage
4.33	21 (Ue ₁)	Substrate bending	Depth 2 mm, 3 times	$\pm (0.1 \% R + 0.01 \Omega)$ no visible damage; no open circuit in bent position
4.7	-	Voltage proof	$U_{RMS} = U_{ins.}$; (60 \pm 5) s	No flashover or breakdown
4.35	-	Flammability	Needle flame test; 10 s	No burning after 30 s

DIMENSIONS

DIMENSIONS AND MASS							
TYPE	H (mm)	L (mm)	W (mm)	W _T (mm)	T _t (mm)	T _b (mm)	MASS (mg)
MCW 0406 AT	0.3 ± 0.05	1.0 ± 0.15	1.5 ± 0.15	> 75 % of W	0.2 + 0.1/ - 0.15	0.2 ± 0.1	1.9

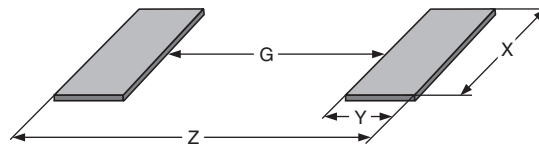
SOLDER PAD DIMENSIONS

RECOMMENDED SOLDER PAD DIMENSIONS				
TYPE	REFLOW SOLDERING			
	G (mm)	Y (mm)	X (mm)	Z (mm)
MCW 0406 AT	0.35	0.55	1.75	1.45

Note

- The rated dissipation applies only if the permitted film temperature is not exceeded. Furthermore, a high level of ambient temperature or of power dissipation may raise the temperature of the solder joint, hence special solder alloys or board materials may be required to maintain the reliability of the assembly. Specified power rating above 125 °C requires dedicated heat-sink pads, which to a great extent depends on board materials and design.

The given solder pad dimensions reflect the considerations for board design and assembly as outlined e.g. in standards IEC 61188-5-x, or in publication IPC-7351. They do not guarantee any supposed thermal properties, particularly as these are also strongly influenced by many other parameters.

Still, the given solder pad dimensions will be found adequate for most general applications, e.g. those referring to “standard operation mode”. Please note however that applications for “power operation mode” or “advanced temperature mode” require special considerations for the design of solder pads and adjacent conductor areas.



Disclaimer

ALL PRODUCT, PRODUCT SPECIFICATIONS AND DATA ARE SUBJECT TO CHANGE WITHOUT NOTICE TO IMPROVE RELIABILITY, FUNCTION OR DESIGN OR OTHERWISE.

Vishay Intertechnology, Inc., its affiliates, agents, and employees, and all persons acting on its or their behalf (collectively, "Vishay"), disclaim any and all liability for any errors, inaccuracies or incompleteness contained in any datasheet or in any other disclosure relating to any product.

Vishay makes no warranty, representation or guarantee regarding the suitability of the products for any particular purpose or the continuing production of any product. To the maximum extent permitted by applicable law, Vishay disclaims (i) any and all liability arising out of the application or use of any product, (ii) any and all liability, including without limitation special, consequential or incidental damages, and (iii) any and all implied warranties, including warranties of fitness for particular purpose, non-infringement and merchantability.

Statements regarding the suitability of products for certain types of applications are based on Vishay's knowledge of typical requirements that are often placed on Vishay products in generic applications. Such statements are not binding statements about the suitability of products for a particular application. It is the customer's responsibility to validate that a particular product with the properties described in the product specification is suitable for use in a particular application. Parameters provided in datasheets and/or specifications may vary in different applications and performance may vary over time. All operating parameters, including typical parameters, must be validated for each customer application by the customer's technical experts. Product specifications do not expand or otherwise modify Vishay's terms and conditions of purchase, including but not limited to the warranty expressed therein.

Except as expressly indicated in writing, Vishay products are not designed for use in medical, life-saving, or life-sustaining applications or for any other application in which the failure of the Vishay product could result in personal injury or death. Customers using or selling Vishay products not expressly indicated for use in such applications do so at their own risk. Please contact authorized Vishay personnel to obtain written terms and conditions regarding products designed for such applications.

No license, express or implied, by estoppel or otherwise, to any intellectual property rights is granted by this document or by any conduct of Vishay. Product names and markings noted herein may be trademarks of their respective owners.

Material Category Policy

Vishay Intertechnology, Inc. hereby certifies that all its products that are identified as RoHS-Compliant fulfill the definitions and restrictions defined under Directive 2011/65/EU of The European Parliament and of the Council of June 8, 2011 on the restriction of the use of certain hazardous substances in electrical and electronic equipment (EEE) - recast, unless otherwise specified as non-compliant.

Please note that some Vishay documentation may still make reference to RoHS Directive 2002/95/EC. We confirm that all the products identified as being compliant to Directive 2002/95/EC conform to Directive 2011/65/EU.

Vishay Intertechnology, Inc. hereby certifies that all its products that are identified as Halogen-Free follow Halogen-Free requirements as per JEDEC JS709A standards. Please note that some Vishay documentation may still make reference to the IEC 61249-2-21 definition. We confirm that all the products identified as being compliant to IEC 61249-2-21 conform to JEDEC JS709A standards.